



# Apple TV 4K (2nd generation)

## Apple Recycler Guide

April 2023

# Contents

- 3 [About This Guide](#)
- 4 [Identification](#)
- 5 [Directive 2012/19/EU Annex VII Components](#)
- 6 [Safety Considerations](#)
- 7 [Recommended Tools](#)
- 8 [Disassembly Instructions](#)
- 16 [Material Categorization of Output Fractions](#)

# About This Guide

Apple Recycler Guides provide guidance for electronics recyclers on how to disassemble products to maximize recovery of resources. The guides provide step-by-step disassembly instructions and information on the material composition to help recyclers direct fractions to the appropriate material recycler.

To conserve important resources, we work to reduce the materials we use and aim to one day source only recycled or renewable materials in our products. A key path to reaching that goal is resource recovery from end-of-life electronics.

Disassembly procedures are intended to be performed only by trained electronics recycling professionals. The recycler is responsible for independently evaluating and ensuring compliance with all applicable environmental, health, and safety laws related to the work. These include but are not limited to laws relating to the management, handling, shipping, and disposal of the outputs of this work as waste and laws in place to ensure the health and safety of all employees who support this work.

For questions or feedback about this guide, email [contactesci@apple.com](mailto:contactesci@apple.com).

# Identification

You can find the model number on the bottom cover of the Apple TV 4K (2nd generation).



*Model number:*  
A2169

# Directive 2012/19/EU Annex VII Components

Directive 2012/19/EU Annex VII requirements apply to the following substances and components.

Substance/Component	Apple Part Name	Removal Instructions
Printed circuit board if the surface is greater than 10 square centimeters	Main logic board, power supply logic board	Follow steps 1–9
External electric cables	Power cord	Follow step 1
No further substances or components as listed in Annex VII		

# Safety Considerations

The recycler is responsible for independently evaluating all activities undertaken by its employees to perform or support the work and ensuring compliance with all applicable health and safety laws related to the work. These include but are not limited to laws relating to the health and safety of all employees who perform or support this work. The recycler is also responsible for evaluating the workspace and ensuring that the area in which the work is to be undertaken is designed using ergonomic best practices and meets all ergonomic requirements to ensure the protection of its employees.

## Personal Protective Equipment

Personal protective equipment should be worn during the entire recycling process.



Wear hand protection



Wear protective clothing



Wear eye protection



Wear foot protection

# Recommended Tools

Miniature pry bar

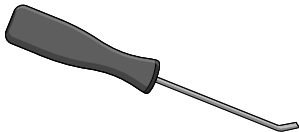

Nail-pulling screwdriver

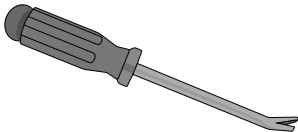

Torx T5 screwdriver

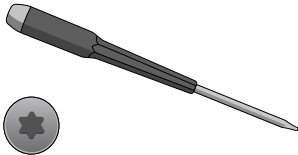

Torx T7 screwdriver

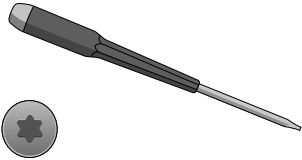

# Disassembly Instructions

1. Unplug the power cord.

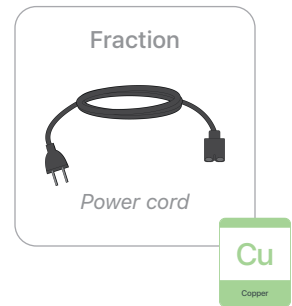

**Warning:** Before continuing disassembly, wait 10 minutes after unplugging the device for stored energy to discharge.

2. Pry off the bottom cover.

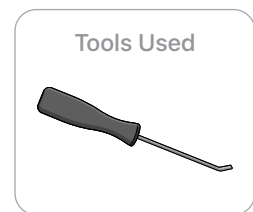
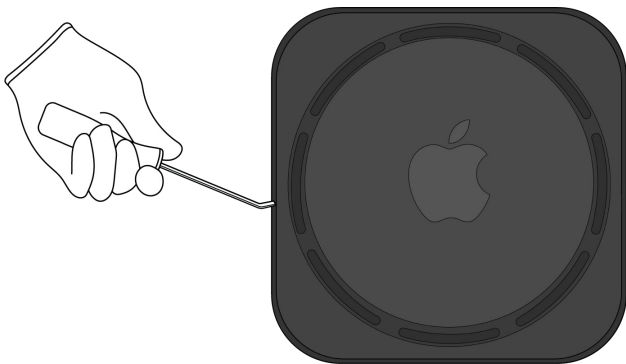



### 3. Remove the fan.

» Unscrew the four Torx T7 fasteners.

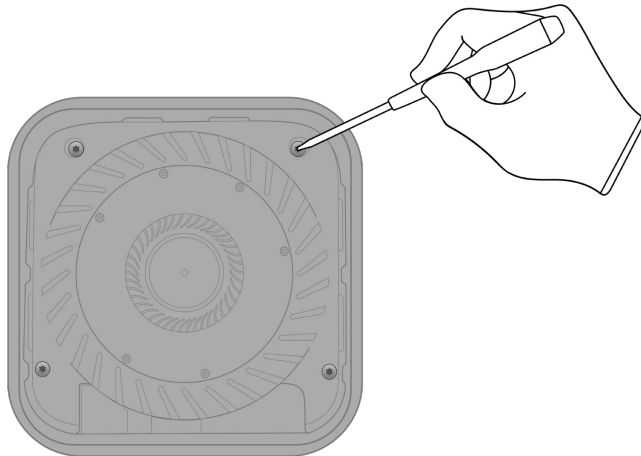

#### Tools Used

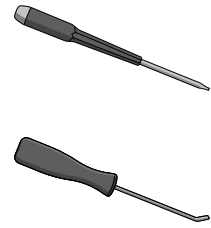

#### Fraction



Fasteners (x4)

Fe

Ferrous

» Pry off the fan.

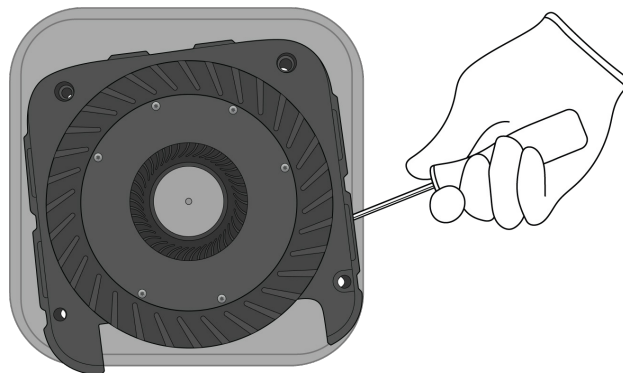

#### Fraction

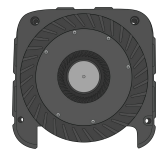

Fan

Cu

Copper

4. Remove the main logic board by unscrewing the four Torx T7 fasteners.

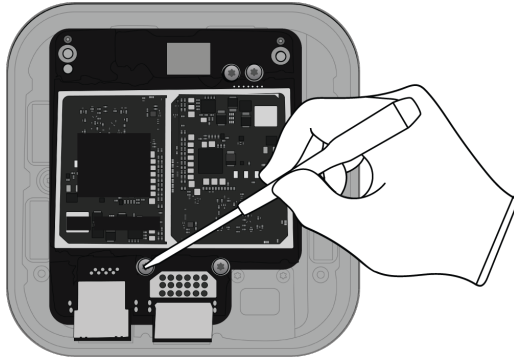

Tools Used

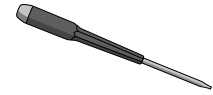

Fraction



Fasteners (x4)

Fe

Ferrous

Fraction

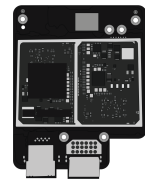

Main logic board

PMs

Precious Metals

## 5. Separate the heat sink from the enclosure.

» *Unscrew the five Torx T7 fasteners.*

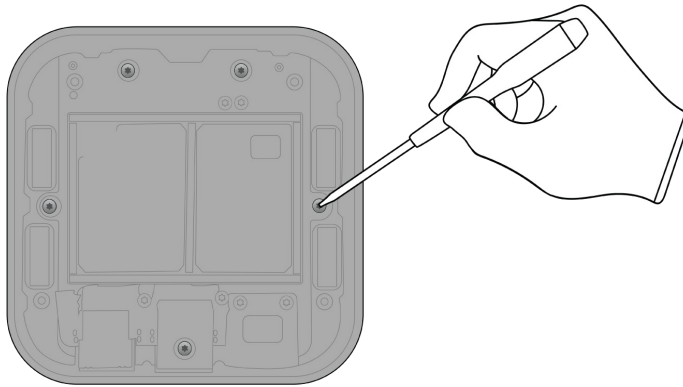

### Tools Used

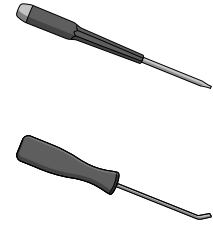

### Fastener



Fasteners (x5)

» *Pry the heat sink out of the enclosure. Set the heat sink aside.*

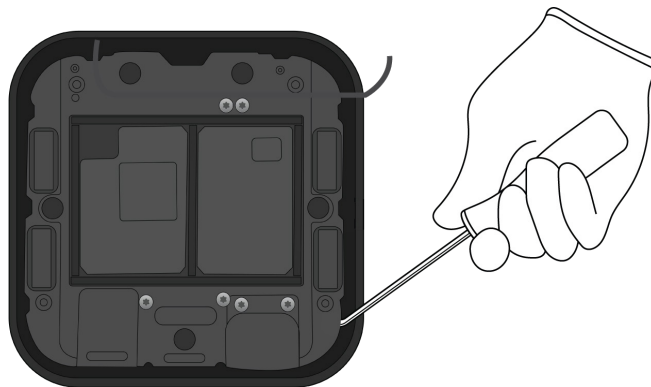

6. Pry off the antenna.

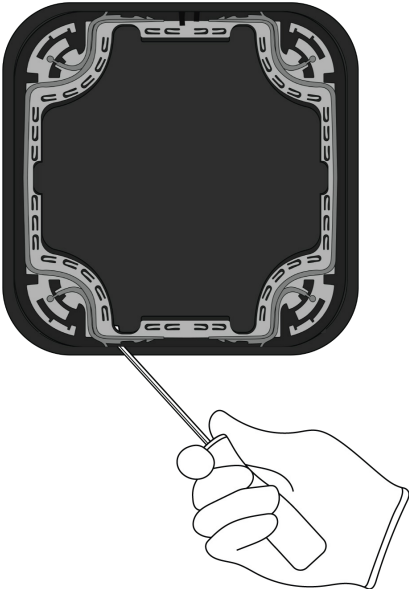

Tools Used

A simple line drawing of a screwdriver with a dark handle and a metal shaft.

Fraction

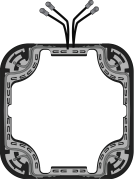
A line drawing of the antenna component, showing its base and the two small protrusions at the top.

Antenna

Cu  
Copper

**7.** Pry off the five fastener standoffs.

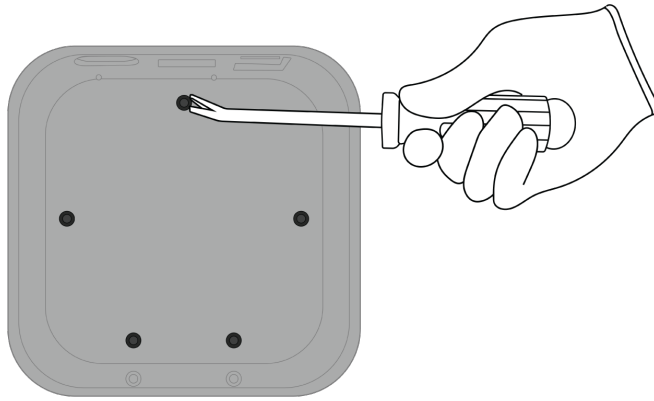

Tools Used

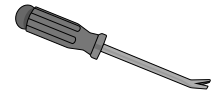

Fraction

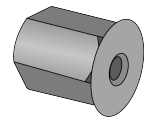

Fastener standoffs  
(x5)

Fe

Ferrous

Fraction



Enclosure

PL

Plastics

## 8. Remove the AC connector from the heat sink.

» Unscrew the two Torx T5 fasteners.

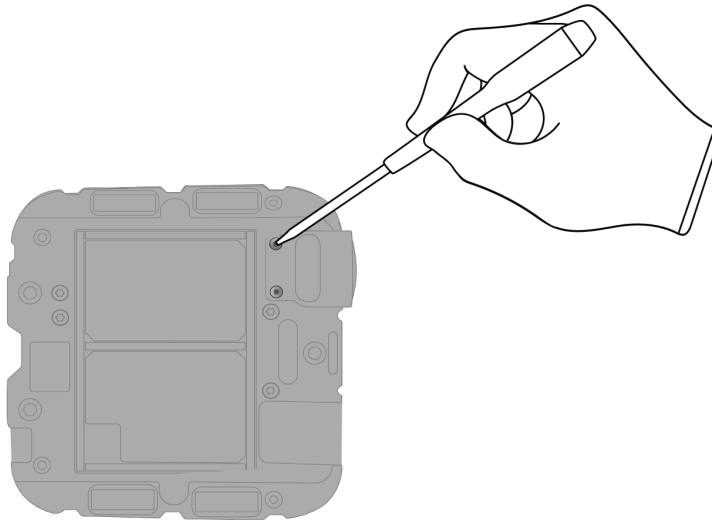

### Tools Used

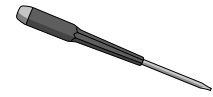

### Fraction



Fasteners (x2)

Fe

Ferrous

» Remove the AC connector by hand.

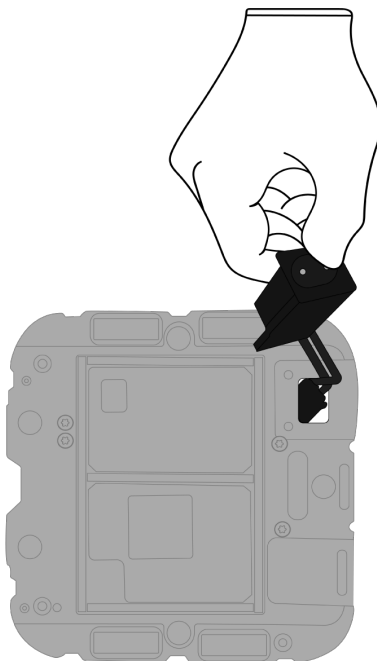

### Fraction



AC connector

Cu

Copper

## 9. Remove the power supply logic board.

» Unscrew the seven Torx T7 fasteners.

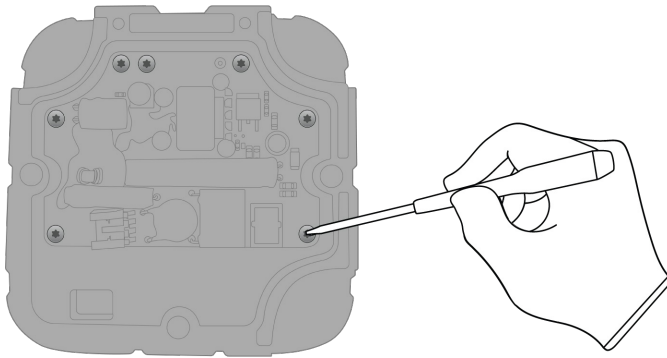

Tools Used

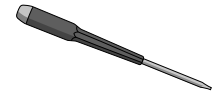

Fraction



Fasteners (x7)

Fe

Ferrous

» Lift the power supply logic board out of the heat sink by hand.

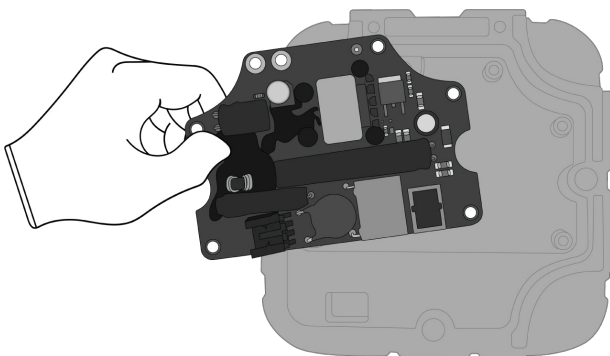

Fraction

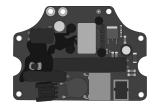

Power supply  
logic board

PMs

Precious  
Metals

Fraction







Heat sink



Al

Aluminum

# Material Categorization of Output Fractions

All outputs from this process must be managed, handled, and disposed of in accordance with applicable waste laws and regulations, including but not limited to the Waste Framework Directive and its national enactments in Europe.

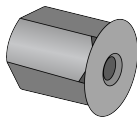
Fraction	Downstream Processing
<p data-bbox="435 604 570 632"><b>Aluminum</b></p>  <p data-bbox="456 827 548 848"><i>Heat sink</i></p>	<p data-bbox="964 604 1273 632"><b>Primary Target Material</b></p>  <p data-bbox="924 856 1313 884"><b>Potential Additional Materials</b></p>  

<p data-bbox="451 1140 553 1167"><b>Ferrous</b></p>  <p data-bbox="423 1308 574 1329"><i>Fasteners (x22)</i></p>  <p data-bbox="388 1514 610 1535"><i>Fastener standoffs (x5)</i></p>	<p data-bbox="964 1140 1273 1167"><b>Primary Target Material</b></p> 
---	--



**Fraction**

**Downstream Processing**

**Logic Boards**

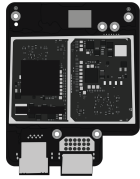

*Main logic board*

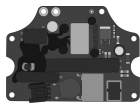

*Power supply logic board*

**Primary Target Material**



**Potential Additional Materials**



**Mixed Electronics**



*Power cord*

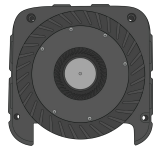

*Fan*

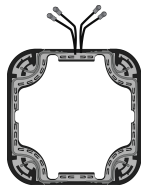

*Antenna*



*AC connector*

**Primary Target Material**



**Potential Additional Materials**



**Fraction**

**Downstream Processing**

**Mixed Plastics**



*Bottom cover*



*Enclosure*

**Primary Target Material**

